

# **zibro**<sup>®</sup>

made by **TÖYÖTÖMI**

## **LC – 32**



GB	OPERATING MANUAL .....	PAGE	2
DE	GEBRAUCHSANWEISUNG .....	PAGE	14
FR	MANUAL D'UTILISATION .....	PAGE	26
NL	GEbruIKSAANWIJZING .....	PAGE	38
ES	INSTRUCCIONES DE USO .....	PAGE	50
IT	ISTRUZIONI D'USO .....	PAGE	62
PT	MANUAL DE INTRUÇÕES .....	PAGE	74
DK	BRUGERVEJLEDNING .....	PAGE	86
NO	BRUKERINSTRUKSEN .....	PAGE	98
SE	INSTRUKTIONERNA INNAN ANVANDNING .....	PAGE	110
FI	KÄYTTÖOHJEET .....	PAGE	122

Thank you for choosing a “TOYOTOMI” product!

Toyotomi products are used by satisfied customers worldwide. In order to assure the comfortable and safe use of our products by customers in each country, our products conform to the safety standards not only in Japan but also in every country around the world we do business with.

Toyotomi tailors its products to satisfy its customer’s needs by always pursuing our business philosophy, “sharing joys in daily living”. We will continue to research, develop and manufacture products that match people’s lifestyle for efficiency, safety and comfort.

We hope that you’ll enjoy your Toyotomi appliance for years to come!

We invite you to read this instruction manual first, to ensure the maximum lifetime for this appliance.

Get to know us better... visit us at [www.toyotomi.eu](http://www.toyotomi.eu) for our full line of products.



**1 READ THE DIRECTIONS FOR USE FIRST.**

**2 IN CASE OF ANY DOUBT, CONTACT YOUR DEALER.**

**3 BEFORE YOU START READING, CONSULT THE MAIN COMPONENTS LIST ON THE LAST PAGE.**

## GENERAL DIRECTIONS FOR USE

*Below you will find the main steps to be taken for using your heater. For more details, please refer to the MANUAL.*

- 1** Remove all packaging materials (*refer to Section A, Fig. A*).
- 2** Fill the removable tank **6** (*refer to Section B, Fig. C*).
- 3** Insert the plug into the wall-socket.
- 4** Ignite the heater using the  key **12** (*refer to Section D*).
- 5** If required, change the temperature using the adjustment keys (*refer to Section E*).
- 6** Switch off the heater by pressing the  key **12**.

- As a fire precaution, the tank must be filled either when the heater has been switched off or in another room than the room where the heater is installed.
- Always ensure that the tank is closed properly after filling it at a safe distance from all sources of heat and open flames (*see Section B*).
- The first time the heater is ignited it will smell like “new” for a short time.
- Store all fuel containers with their original caps and seals in a cool and dark place.
- Fuel ages. Use new fuel at the start of every heating season.
- Only use high quality and water-free pure paraffin in accordance with local legislation.
- Before changing brands and/or types of fuel make sure that the mobile heater first completely empties all of the remaining fuel inside the heater.

## WHAT YOU NEED TO KNOW IN ADVANCE

### VENTILATE SUFFICIENTLY

Read this user manual carefully before using the appliance and keep it for future reference. Install this device only when it complies with local/national legislation, ordinances and standards. This product is intended to be used as a heater in residential houses and is only suitable for use in dry locations, in normal household conditions, indoors in living room, kitchen and garage.

For comfortable and safe heating ensure that there is sufficient ventilation.

**NOTE:** To avoid unexpected shut off, we recommend to put a door or window ajar when the heater is operating.

Regardless of the model, you must always make sure that the heater is used in a room large enough to enable the heater to be used safely without extra ventilation (*refer to Section P*). If the room is smaller than required, you must always open a door or window slightly (ensuring an opening of approx. 2.5 cm). It is important that every room where the heater is used has sufficient air intake and efficient air outflow (both openings must have a minimum cross section of 50 cm<sup>2</sup>).

We also recommend doing this in highly insulated or draught-free rooms and/or at altitudes above 1300 metres. Do not use your heater in cellars or other underground areas.

No modifications to the safety system are allowed, as that will invalidate the guarantee that the air probe will work properly. Consult your dealer in case of doubt.

**ESPECIALLY FOR FRANCE:** Your heater was designed to operate exclusively on fuel for liquid fuel-operated mobile heaters in accordance with the Decrees of 18-07-2002 and 25-06-2010. The use of other fuels is forbidden.

Ask your dealer or check our website for the addresses of our retailers.

The liquid fuel-operated mobile heater is intended as an extra heater, and not as a continuous source of heat.

**ESPECIALLY FOR UNITED KINGDOM:** Only use Class C1 paraffin fuel in accordance with BS2869; Part 2, or equivalent.

The user must comply with the following instructions for proper use:

#### DO NOT

- use the liquid fuel-operated mobile heater in caravans, boats, and vehicle cabins.
- use the liquid fuel-operated mobile heater in insufficiently ventilated rooms (consult the table of properties for the minimum dimensions of the room to be heated), underground rooms and / or at a height of over 1300 metres.
- modify the heater safety features.

The use of this type of heating in public rooms is subject to prior regulatory permission. Obtain proper information on this in advance.

### THE RIGHT FUEL

Your heater has been designed for use with high-quality water-free pure paraffin oil. Only fuels of this kind will ensure clean and proper burning. Lower quality fuel may result in:

- increased possibility of malfunctioning
- incomplete combustion
- reduced heater lifetime
- smoke and/or fumes
- deposits on the grid or mantle

Using the right fuel is therefore essential for safe, efficient, and comfortable use of your heater.

Damage and/or malfunctions of the heater due to the use of other than high-quality water-free pure paraffin oil is **not** covered by the warranty.

Always refer to your local dealer for the right fuel for your heater.



*Only the use of the correct fuel will ensure safe, efficient, and comfortable use of your heater.*

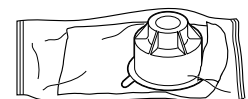

*This transportation cap is packed separately in the box. Only this cap ensures trouble-free transportation of the heater after use. Store it well!*

#### 14 TIPS FOR SAFE USE

- 1 Children should be supervised to ensure that they do not play with the appliance.
- 2 DO NOT move the heater when it is burning or still hot. DO NOT refill nor service the heater when it is burning or still hot.
- 3 Position the front of the heater at a distance of minimum 1.5 metres from walls, curtains, and furniture.
- 4 DO NOT use the heater in dusty rooms. You will not have optimum burning in such rooms. DO NOT use the heater in the immediate surrounding of a bath, a shower or a swimmingpool.
- 5 Switch off the heater, before you leave or go sleeping. Unplug the heater as well, when you go away for a longer period of time (e.g. holidays).
- 6 Store and move fuel only in suitable tanks and jerrycans.
- 7 Make sure that the fuel is not exposed to heat or extreme temperature changes. ALWAYS store the fuel in a cool, dry and dark place (sunlight will affect the quality).
- 8 NEVER use the heater in places where harmful gasses or fumes may be present (e.g. exhaust gasses or paint fumes).
- 9 Beware that the grid of the heater becomes hot. If the appliance is covered there is a risk of fire.
- 10 ALWAYS make sure that there is sufficient ventilation.
- 11 This appliance is not intended for use by persons (including children) with reduced physical, sensory or mental capabilities, or lack of experience and knowledge, unless they have been given supervision or instruction concerning use of the appliance by a person responsible for their safety.
- 12 This appliance can be used by children aged from 8 years and above and persons with reduced physical, sensory or mental capabilities or lack of experience and knowledge if they have been given supervision or instruction concerning use of the appliance in a safe way and understand the hazards involved.
- 13 Children shall not play with the appliance.
- 14 Cleaning and user maintenance shall not be made by children without supervision.

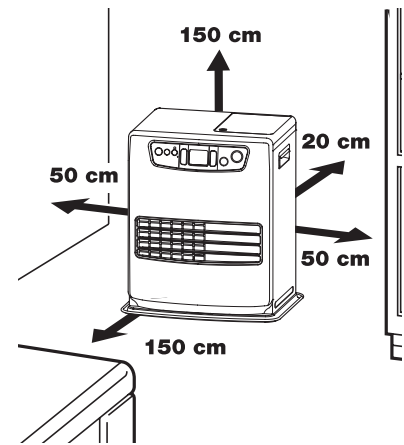

Defective electrical devices and batteries must be kept separate from household waste. Ensure that there is effective recycling where possible. Ask your local council or dealer for expert advice on recycling.



# MANUAL

## A INSTALLING THE HEATER

- 1 Carefully remove your heater from the box and check the contents. In addition to the heater you also need to have:
  - a manual fuel pump
  - a transportation cap
  - these directions for useKeep the box and the packaging materials (Fig. A) for storage and/or transportation.
- 2 Open the lid of the removable tank ④ and remove the piece of cardboard.
- 3 Fill the removable tank as indicated in *Section B*.
- 4 The floor should be firm and completely level. Reposition the heater, when it is not level. Do not try to correct the situation by placing books or other goods under the heater.
- 5 Insert the plug ⑩ into the wall-socket (230 Volts - AC / 50 Hz) and set the correct time using the adjustment keys ⑭ (refer to *Section C*).
- 6 Your heater is now ready for use.

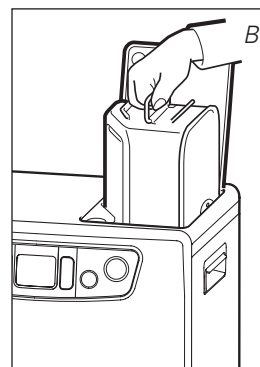
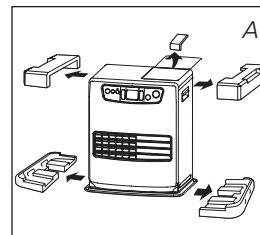

### SET ALTITUDE

If the heater is used at a height of over 800 m, use the altitude mode.

Push the altitude button ⑳ with thin rod like a clip and plug into the outlet simultaneously.

NOTE: When the altitude mode is set, the altitude mark "▲" is shown on the display.

NOTE: In the event of power failure or disconnection of heater, the altitude setting will remain.

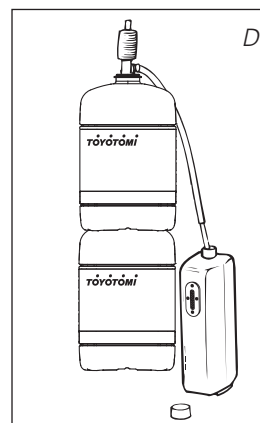
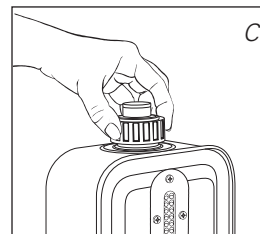

**!** Do not use the heater at a height of over 1300 meters.

## B FILLING FUEL

Fill the removable tank in a suitable place since there can always be some spillage. Follow the procedure below:

- 1 Make sure that the heater is switched off.
- 2 Open the upper lid and lift the removable tank out of the heater (Fig. B). Put down the removable tank (cap pointing upwards, handle on floor) and screw off the fuel cap (Fig. C).  
NOTE: Some drops may leak from the tank.
- 3 Fill the removable tank using a fuel pump (refer to fuel pump operation instructions.) Make sure that it is in a higher position than the removable tank (Fig. D). Insert the ribbed hose into the opening of the removable tank.

- 4 Check the removable tank fuel gauge while filling the tank (Fig. E). Stop filling once the gauge indicates that the tank is full. Never overfill the tank, especially not when the fuel is very cold (fuel expands when it heats up).
- 5 Let the remaining fuel in the pump flow back into the jerrycan and carefully remove the pump. Carefully screw the fuel cap back on the tank. Clean off any spilled fuel.
- 6 Check whether the fuel cap is straight and tightened properly. Reinstall the removable tank in the heater (cap down). Close the lid.

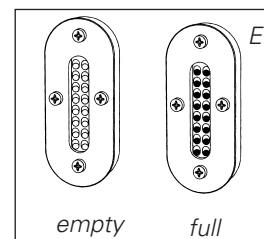

## C SETTING THE CLOCK

It is only possible to set the correct time, when the heater is connected to the mains and not burning. Use the adjustment keys 14 to set the time. First press either of the two keys to switch on the function (the 4-digit 11 will start blinking). Next, set the hours using the key on the left (▼hour) and the minutes using the key on the right (▲min.). Press once to increase the value by one step. When you hold down the key, the value will continue going up, until you release the key again. After approximately 10 seconds the 4-digit will stop blinking and the setting will be locked (Fig. F). 5 minutes after switching off the heater, the information on the display will disappear and the heater will automatically switch into the stand-by position.



F: When the 4-digit stops blinking, the setting has been locked to the indicated value.

**!** When the heater has been unplugged (or after a power failure), the time needs to be set again.

## D IGNITING THE HEATER

When used for the first time, a new heater may give out a smell for a short while. You should therefore provide extra ventilation.

**!** Always ignite the heater with the ⏻ button 12. Never use matches or a cigarette lighter.



Just press the ⏻ button 12 to ignite the heater. The POWER lamp will start blinking, indicating that the ignition procedure has started. This will take a short while. Once the heater is burning, the POWER lamp will remain lit (red). The information display 11 will show two numbers. The light next to them indicates that these numbers refer to the temperatures (Fig. G). The actual room temperature is indicated below ROOM, while the temperature setting is indicated below SET. The latter can be changed with the adjustment keys (refer to Section E).

Prior to igniting the heater, always check for sufficient fuel in the removable tank.



G: The required temperature on the left, the measured temperature on the right.



## E SETTING THE REQUIRED TEMPERATURE

The temperature setting can only be adjusted, when the heater is burning. Use the adjustment keys 14 to adjust the temperature. First press either of the two keys to switch on the function (the °C mark 11 will start blinking). Next, adjust the temperature using the key on the right (▲min.) to set the temperature to a higher setting and the key on the left (▼hour) to lower the temperature. Press once to increase the value one step. After approximately 10 seconds the °C mark will stop blinking and the setting will be locked (Fig. G).

The available temperature settings range from 6°C minimum to 28°C maximum. When the heater has been unplugged (or after a power failure), the temperature will reset to the factory setting of 20°C.

## F USING THE TIMER

The timer allows you to switch on the heater automatically at a preset time. In order to switch on the timer, the correct time must have been set (*refer to Section C*) and the heater should be off. Follow the procedure below:

- 1 Press the  button **12** and then the TIMER key **15** immediately after that. The TIMER lamp **19** and the 4-digit **11** will start blinking.
- 2 Use the adjustment keys **14** to set the time at which the heater must ignite. Use the key on the left ( hour) to set the hours and the key on the right () to set the minutes (interval of 5 minutes).
- 3 After approximately 10 seconds the 4-digit will show CLOCK again and the TIMER lamp **19** will light up, indicating that the timer function has been activated (Fig. H).
- 4 The timer will ensure that the room will have been heated to approximately the required temperature at the set time.

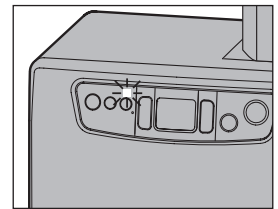

H: The TIMER indicator light indicates that the timer function has been switched on.

**!** When you want to switch off the heater and ignite it again with the timer, all you have to do is press the TIMER key (*refer to Section G*).

Press the  button **12** once to clear the timer setting.

## G SWITCHING OFF THE HEATER

There are two ways to switch off the heater.

- 1 Press the  button **12**. The information display will show the CLOCK signal. Within approximately one minute the flame will have extinguished.
- 2 Press the TIMER key **15**, when you want to switch off the heater and ignite it again with the timer the next time. This not only switches off the heater, but it also activates the timer function. You can change the required time with the adjustment keys **14** (*refer to Section F*).



## H THE INFORMATION DISPLAY

The information display **11** not only serves as an indicator of the (set) time and temperature (*Sections C, E, and F*), it also indicates any malfunctioning of the heater. The code on the information display tells you what is the matter:





In case of any malfunctioning the information display will tell you what is the matter.



CODE	INFORMATION	WHAT TO DO
E - 0	Temperature within the heater too high.	Cool-down and re-ignite.
F - 0	Power interrupted.	Re-ignite the heater.
E - 1	Faulty thermostat.	Contact your dealer.
F - 1	Faulty burner thermistor.	Contact your dealer.
E - 2	Starting problems.	Contact your dealer.
E - 5	Tipping-over protection.	Re-ignite the heater.
E - 6	Poor burning.	Contact your dealer.
E - 7	Room temperature above 32°C.	If necessary, re-ignite the heater.
E - 8	Defective booster.	Contact your dealer.
E - 9	Air filter dirty; or Fuel pump dirty.	Clean filter. Contact your dealer.
65 Hr	The heater has been in operation continuously for a period of 65 hours and has turned itself off automatically.	Switch the heater back on.
-- : -- + 	Out of fuel.	Refill removable tank.
-- : -- + 	Too little ventilation.	Ventilate better.

Always contact your dealer for any malfunctioning not listed above and/or when the error keeps occurring after taking the corrective measure as described above.

### AUTOMATIC DEACTIVATION

This heater is fitted with a safety system that ensures that it switches off automatically after 65 hours continuous operation. The following will then appear in the display: 65 Hr. If desired, you can switch the heater on again by pressing the  button  (see Section D).



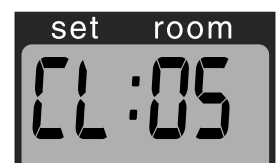

### AUTOMATIC CLEANING MODE

When the heater has been burning continuously for two hours at its highest setting, the burner will automatically start an autoclean procedure. The display will show the autocleaning code CL:05 running back to CL:01. The procedure takes 5 minutes, during which the heater will burn at its lowest setting, while the burner autocleans. When the burner is clean again, the heater will automatically switch back to the highest setting again.



### CHILDPROOF LOCK / PARENTAL CONTROL

The childproof lock can be used to prevent children accidentally changing the heater settings. When the heater is burning and the childproof lock is on, the heater can only be switched off. Other functions are blocked then. If the heater has already been switched off, the childproof lock also prevents accidental ignition of the heater. Activate the childproof lock by pressing the appropriate key  and holding it down for more than 3 seconds. The KEY-LOCK indicator  will appear on the information display (Fig. I), indicating that the childproof lock has been activated. Switch off the childproof lock by pressing the key  and holding it down for more than 3 seconds once again.



I: When the  mark appears, the childproof lock has been activated.

## J THE CORRECT USE OF 'SAVE'

The 'SAVE' function allows you to limit the temperature. When this function is activated, the heater will automatically switch off, when the room temperature exceeds the set temperature by 3°C. Subsequently, when the room temperature has dropped again to the set temperature, the heater will automatically switch on again. Activate the 'SAVE' setting by pressing the appropriate **16** key. The SAVE indicator light will light up (Fig. J). Switch off the function by pressing the SAVE key once again.



J: When the SAVE light lights up, the heater will automatically switch on or off in order to remain within a specified temperature range.



Without the 'SAVE' setting your heater will maintain the set temperature by approximation as well, by adjusting its heating capacity. 'SAVE' is an economy setting, which you can use when, for instance, you are not present in the room or to keep it frost-free.

## K THE 'FUEL' INDICATOR

When the FUEL indicator appears, it means that there is only fuel left for 10 more minutes. The count-down of the remaining heating time can be seen in the information display **11** (Fig. K). Now you have two options:

- you remove the fuel tank and refill it outside the living room (*Section B*) or
- you push the button extension **18**. By pushing this button, the remaining heating time will extend to 60 minutes.

The heater will automatically switch back to its lowest position. In the display the number 60 will appear, which will decline to 10. At the arrival of 10, you will hear an alarm signal every two minutes, warning you to refill the removable tank. If you do not react, the heater will extinguish by itself. The heater will also sound a warning signal, when it switches off. The fuel indicator will blink, while four lines (---) are blinking in the information display. You can stop this by pressing the  button **12** once more.

Once the heater has used up all its fuel and extinguished, it will take some time, after the refill, before the heater is completely ready for use again.

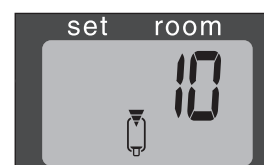

K: When the FUEL indicator has appeared, the information display will show the number of minutes of fuel left in the tank.

## L THE 'VENT' INDICATOR

When the VENT indicator starts blinking, this is a sign that the room is not vented sufficiently (Fig. L). The heater will switch off automatically. If the indicator continues blinking after extra ventilation, please contact your dealer.

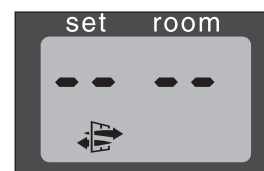

L: A blinking VENT indicator is a sign that you need extra ventilation.

## M MAINTENANCE

Switch off the heater and let it cool down, before you start any maintenance work. Also disconnect the plug from the mains. Your heater needs hardly any maintenance. It is, however, important that you clean the vent filter **8** with a vacuum cleaner and the grid **2** with a damp cloth, both on a weekly basis. Regularly inspect the fuel filter as well:

**1** Remove the removable tank **6** from the heater and remove the fuel filter (Fig. M). Some drops may leak from the filter; keep a cloth at hand.

**2** Remove the dirt by tapping the fuel filter upside-down against a hard surface. **(Never clean it with water!)**

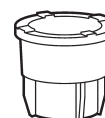

Fuel filter

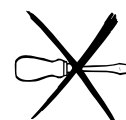
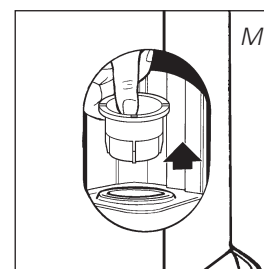

- 3 Reinstall the fuel filter into the heater.

We recommend that you remove dust and stains from time to time with a damp cloth, because otherwise these may cause stains that are hard to remove.

**!** Do not remove any heater components yourself. Always contact your dealer for repairs. When the power cord is damaged, it may only be replaced by an authorised fitter. Use a new cord of the type H05 VV-F.

## **N** STORAGE (END OF THE HEATING SEASON)

At the end of the heating season, you must store the heater in a dust-free place, if possible in its original packaging. Unused fuel cannot be used in the next heating season. We therefore recommend that you burn up all fuel. If there is still some fuel left, do not throw it away, but dispose of it in accordance with the local regulations for the disposal of domestic chemical waste.

Always start the new heating season with fresh fuel. When you start re-using the heater follow the instructions again (*starting from Section A and as specified*).

## **O** TRANSPORTATION

Take the following measures to avoid fuel leakage during the transportation of the heater:

- 1 Let the heater cool down.
- 2 Remove the removable tank **6** from the heater and remove the fuel filter (*refer to Section M, Fig. M*). Some drops may leak from the filter; keep a cloth at hand. Store the fuel filter and the removable tank outside the heater.
- 3 Place the transportation cap into the position of the fuel filter (Fig. N). Press it tight. The transportation cap will, as much as possible, prevent oil leakage from the heater during transport.
- 4 Always move the heater in an upright position.
- 5 Make the fixed tank empty with a fuel pump before transportation or in case of wrong or dirty fuel. First remove the fuel filter and then insert the fuel pump into the empty fixed tank. Follow the same procedure if the fuel tank contains water.

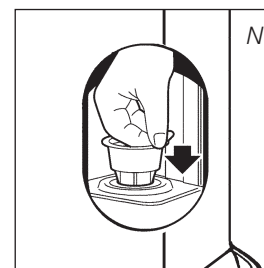

Transportation cap 

## P SPECIFICATIONS

Ignition	electrical	Dimensions (mm)	width	376
Fuel	paraffin	including base plate:	depth	296
Capacity (kW) max.	3.20		height	428
Capacity (kW) min.	0.80	Accessories:	- manual fuel pump	
Suitable space (m <sup>3</sup> )**	48-120		- transportation cap	
Fuel consumption (l/hr)*	0.333	Mains	230 V	
			-- AC / 50 Hz	
Fuel consumption (g/hr)*	267	Electrical consumption:		
Burning time per tank (hr)*	16.2	- igniter	320 W	
Capacity removable tank (litres)	5.4	- continuous	13 W	
Weight (kg)	8.0	Fuse rating	250V, 5A	

\* At maximum setting \*\* Specified values are indicative

## Q WARRANTY PROVISIONS

Your heater comes with a 48-month warranty starting on the date of purchase. Within this period all defects in material or workmanship will be repaired without any charge. The following provisions shall apply regarding this warranty:

- 1 We expressly dismiss all other claims for damages, including consequential damages.
- 2 Any repairs or replacements of components within the term of warranty will not result in an extension of the term of warranty.
- 3 The warranty shall no longer apply, when the heater has been modified, non-original parts have been used, or when it is repaired by third parties.
- 4 The warranty shall not apply to parts that are subject to normal wear, such as the burner mat, any kind of gasket and the manual fuel pump.
- 5 The warranty shall only apply, when you present the original, dated proof of purchase, provided no changes have been made to it.
- 6 The warranty shall not apply to damages caused by actions not in compliance with the Directions for Use, neglect, and the use of an incorrect type of fuel, or fuel past its use-by date. The use of incorrect fuel can even be dangerous\*.
- 7 Transportation costs and the risks involved during the transportation of the heater or heater components shall always be at the expense of the purchaser.



In order to avoid unnecessary costs, we recommend that you always read the 'Directions for Use' carefully first. In case they offer no solution, please take the heater to your dealer for repair.

\* Highly inflammable substances may induce uncontrollable burning, causing flames to break out. Should this happen, never try to move the heater, but always switch off the heater immediately. In case of emergency you may use a fire extinguisher, but only a type B extinguisher: a carbon dioxide or powder extinguisher.

## MAIN COMPONENTS

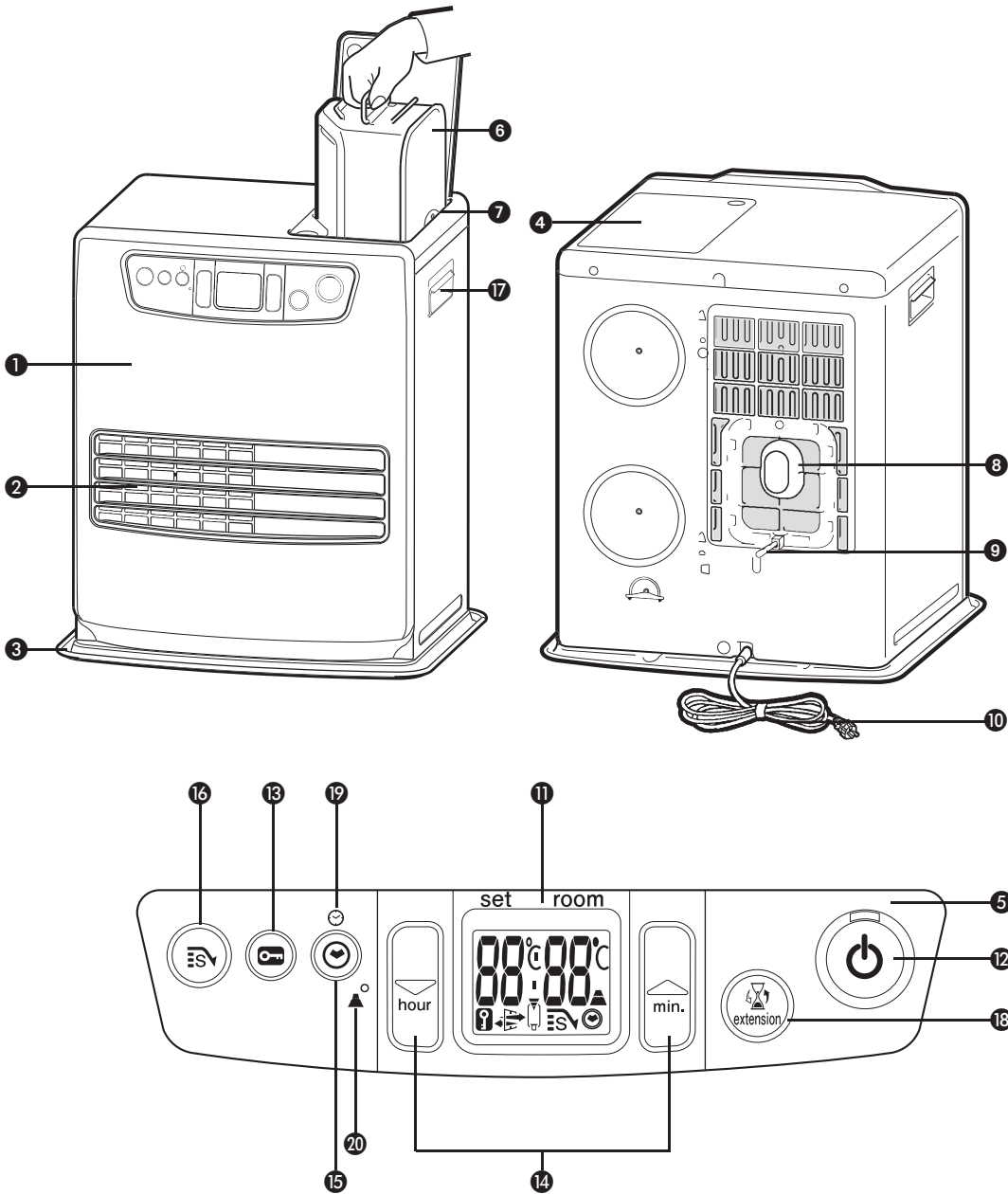

- ① Front plate
- ② Grid
- ③ Base plate
- ④ Lid for removable tank
- ⑤ Operation panel
- ⑥ Removable tank
- ⑦ Fuel gauge removable tank
- ⑧ Vent filter
- ⑨ Thermostat
- ⑩ Plug + cord
- ⑪ Information display
- ⑫ ⏻ key
- ⑬ Childproof lock
- ⑭ Adjustment keys (time and temperature)
- ⑮ Timer
- ⑯ SAVE key
- ⑰ Handle
- ⑱ Extension
- ⑲ Timer lamp
- ⑳ Altitude setting button



## Distributed in Europe by TOYOTOMI EUROPE SALES B.V.

This product is not suitable for primary heating purpose.

Should you require further information or should particular problems occur that are not dealt with in this operating manual, please visit our website [www.toyotomi.eu](http://www.toyotomi.eu) or contact our Sales Support (you find its phone number on [www.toyotomi.eu](http://www.toyotomi.eu))

Dieses Produkt eignet sich nicht als Hauptheizgerät.

Falls Sie weitere Informationen wünschen, oder sollten besondere Probleme auftreten, die in dieser Bedienungsanleitung nicht ausführlich genug behandelt werden, besuchen Sie bitte unsere Website ([www.toyotomi.eu](http://www.toyotomi.eu)), oder fordern Sie die benötigte Auskunft von unserem Kundendienst an (Telefonnummer auf [www.toyotomi.eu](http://www.toyotomi.eu))

Ce produit ne peut pas être utilisé comme chauffage principal.

Vous souhaitez obtenir des informations supplémentaires ou si vous rencontrez un problème, rendez-vous sur notre site Web ([www.toyotomi.eu](http://www.toyotomi.eu)) ou contactez notre service client (vous trouverez l'adresse et le numéro de téléphone sur [www.toyotomi.eu](http://www.toyotomi.eu))

Dit product is niet geschikt voor gebruik als primaire verwarming.

Wenst u nadere informatie, of indien er bijzondere problemen optreden die in deze gebruiksaanwijzing niet behandeld zijn, bezoekt u dan onze website [www.toyotomi.eu](http://www.toyotomi.eu) of vraag de benodigde informatie op bij de afdeling Sales Support (adres en telefoonnummer op [www.toyotomi.eu](http://www.toyotomi.eu))

Este producto no es adecuado para calefacción primaria.

Si necesitara más información o surgiera algún problema concreto que no abarque este manual operativo, visítenos en [www.toyotomi.eu](http://www.toyotomi.eu) o contacte con nuestro equipo de asistencia postventa (encontrará el número de teléfono en [www.toyotomi.eu](http://www.toyotomi.eu)).

Il presente prodotto non è adatto a funzioni di riscaldamento primario.

In caso aveste bisogno di ulteriori informazioni o riscontraste particolari problemi che non sono presi in considerazione nel presente manuale, vi invitiamo a visitare il nostro sito [www.toyotomi.eu](http://www.toyotomi.eu) o contattare la nostra assistenza (il cui numero di telefono è indicato nel nostro sito [www.toyotomi.eu](http://www.toyotomi.eu))

Este produto não é adequado para fins de aquecimento principal.

Caso necessite de mais informações ou se ocorrerem problemas específicos que não constem neste manual de instruções, por favor, visite nosso website [www.toyotomi.eu](http://www.toyotomi.eu) ou entre em contato com o nosso Suporte de Vendas (encontrará o número de telefone em [www.toyotomi.eu](http://www.toyotomi.eu)).

Dette produkt er ikke egnet til brug som primær opvarmingskilde.

Hvis du ønsker yderligere information eller, hvis der opstår problemer, som ikke behandles i brugsanvisningen, bedes du besøge vores website [www.toyotomi.eu](http://www.toyotomi.eu) eller kontakt afdelingen Sales Support (adresse og telefonnummer på [www.toyotomi.eu](http://www.toyotomi.eu)).

Dette produkt er ikke egnet for primær oppvarming.

Om du ønsker mer informasjon, eller om et problem har dukket opp som ikke er dekket i disse instruksjonene, besøk oss gjerne på [www.toyotomi.eu](http://www.toyotomi.eu) eller be om den nødvendige informasjonen fra avdelingen for brukerstøtte (adresse og telefonnummer kan finnes på [www.toyotomi.eu](http://www.toyotomi.eu)).

Denna produkt lämpar sig inte för primär uppvärmning.

Om du önskar mer information, eller om några problem uppstår som inte har berörts i dessa instruktioner, besök då vår hemsida [www.toyotomi.eu](http://www.toyotomi.eu) eller begär den nödvändiga informationen från Säljstøtt avdelningen (adress och telefonnummer finns på [www.toyotomi.eu](http://www.toyotomi.eu)).

Tämä tuote ei sovellu ensisijaiseksi lämmittimeksi.

Jos haluat lisätietoja tai kohtaat ongelmia, joita ei käsitellä näissä ohjeissa, verkkosivustolla osoitteessa [www.toyotomi.eu](http://www.toyotomi.eu) tai pyydä tarvittavat tiedot myynnin tukiosastolta (osoite ja puhelinnumero löytyy sivustolta [www.toyotomi.eu](http://www.toyotomi.eu)).



Kerosun®, Toyostove®, Toyoset®, Toyotomi® and Zibro® for the use of paraffin heaters are all registered trademarks of TOYOTOMI Co., Ltd. - Japan.

Zibro® brand paraffin heaters are made in JAPAN and imported by Toyotomi Europe Sales b.v.